



# Internet上两个主机间数据发送的全过程解析

《两个主机通过路由网络传输IP数据包》

15卓越张海鑫



## 第1步：

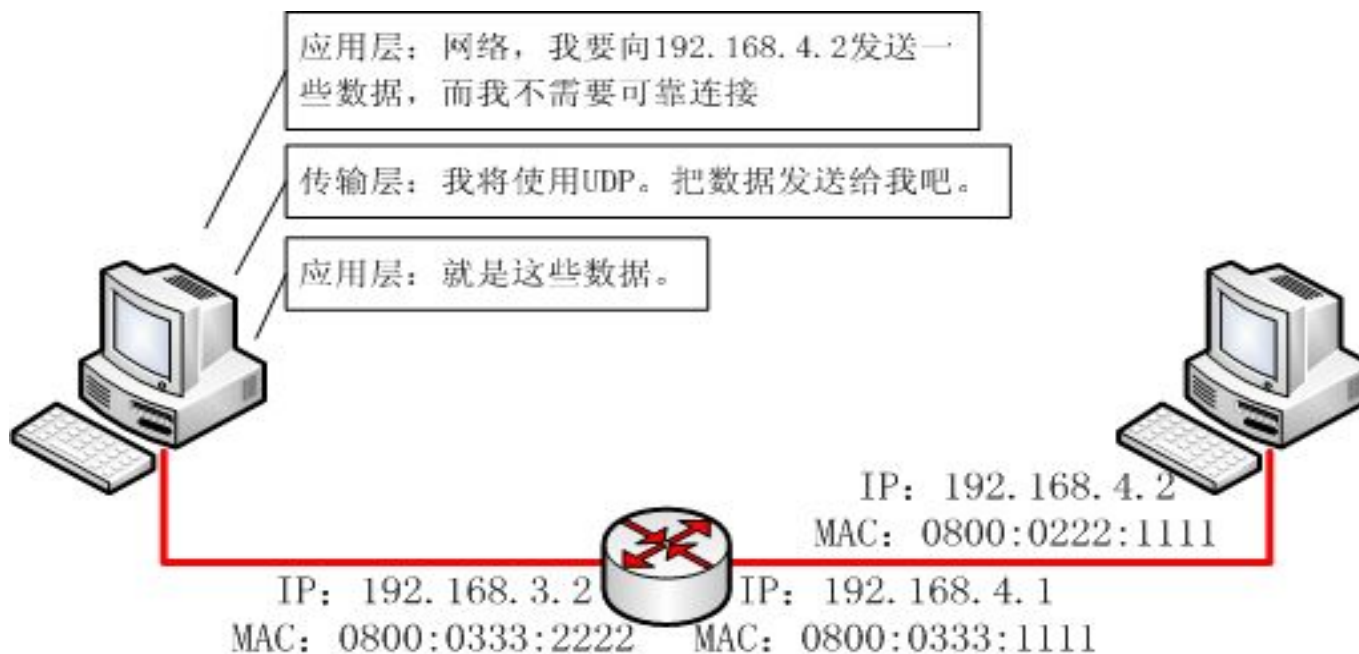



## 第2步：

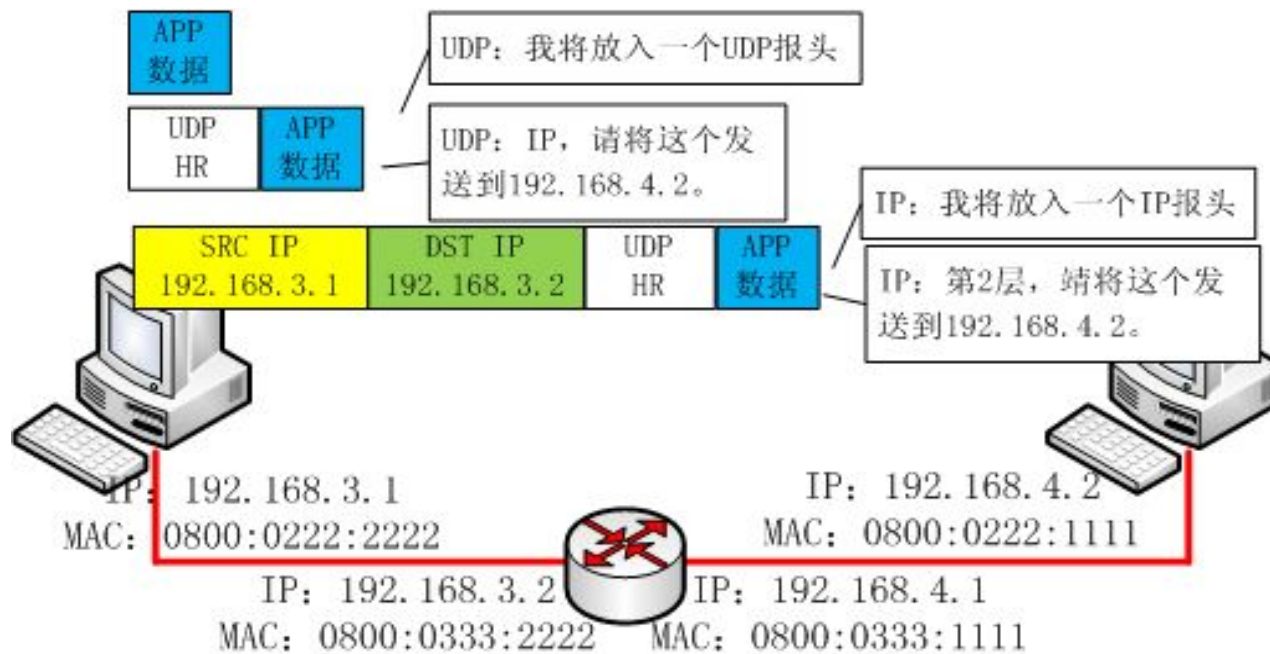



## 第3步：

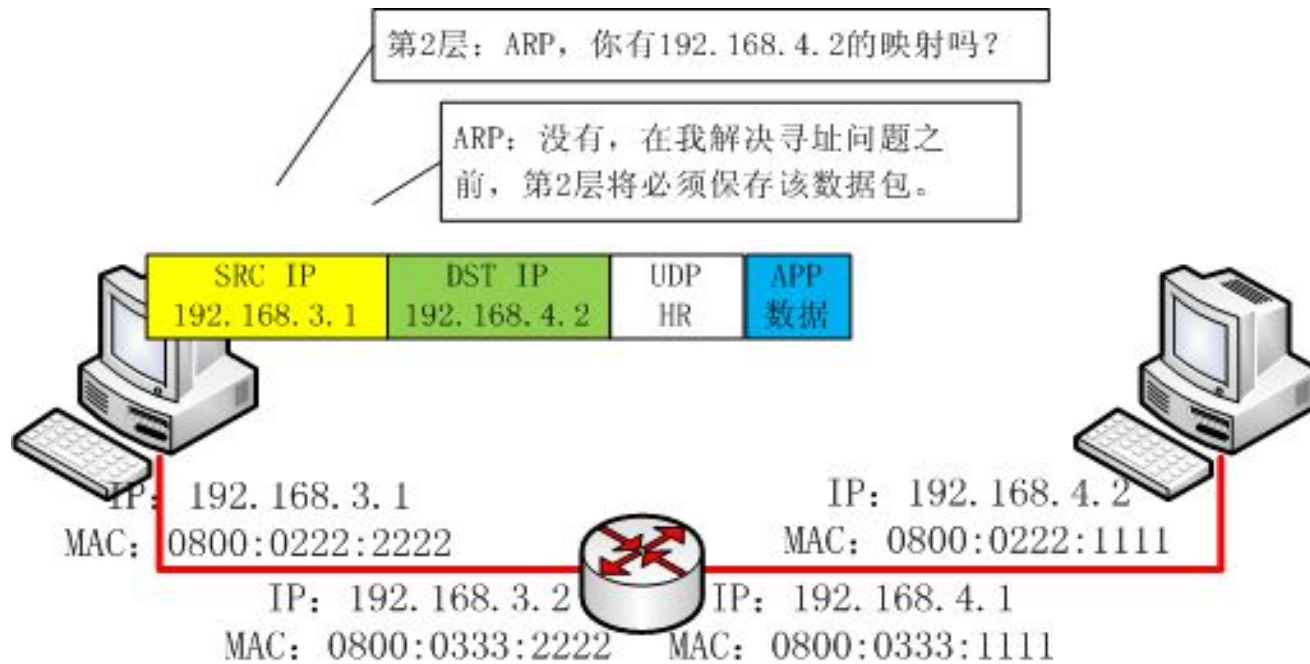



## 第4步：

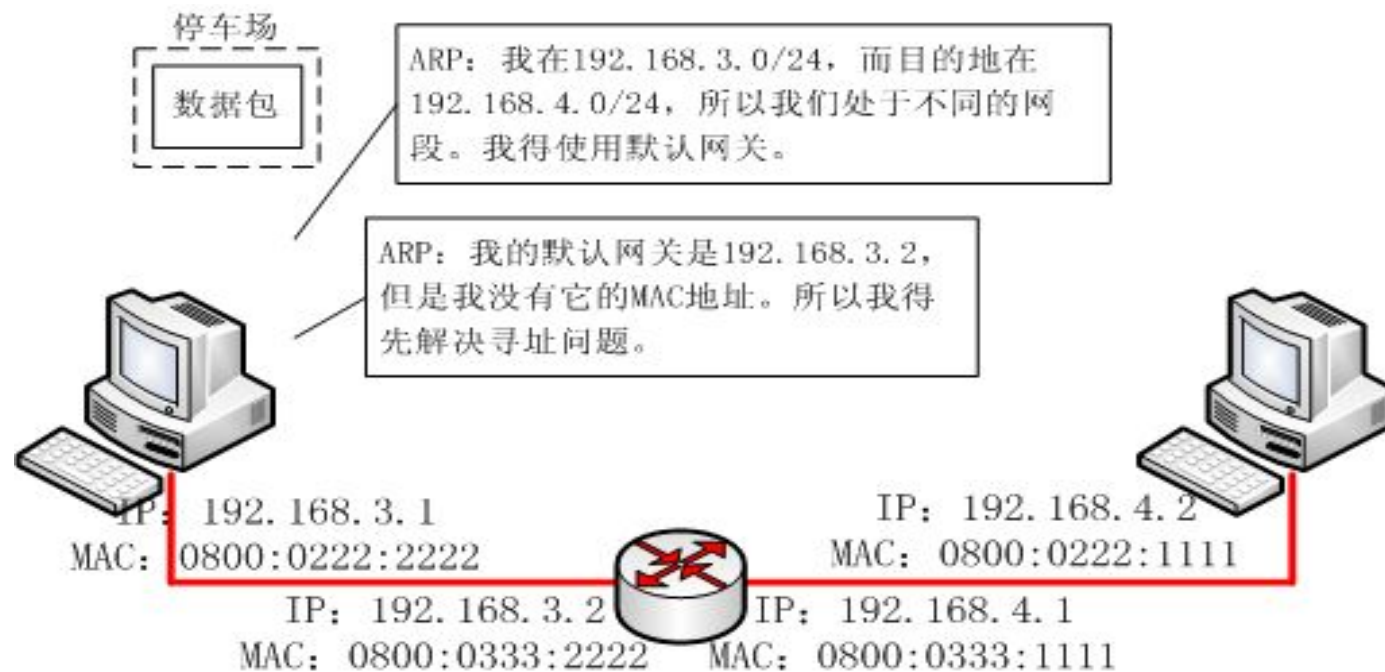



## 第5步：

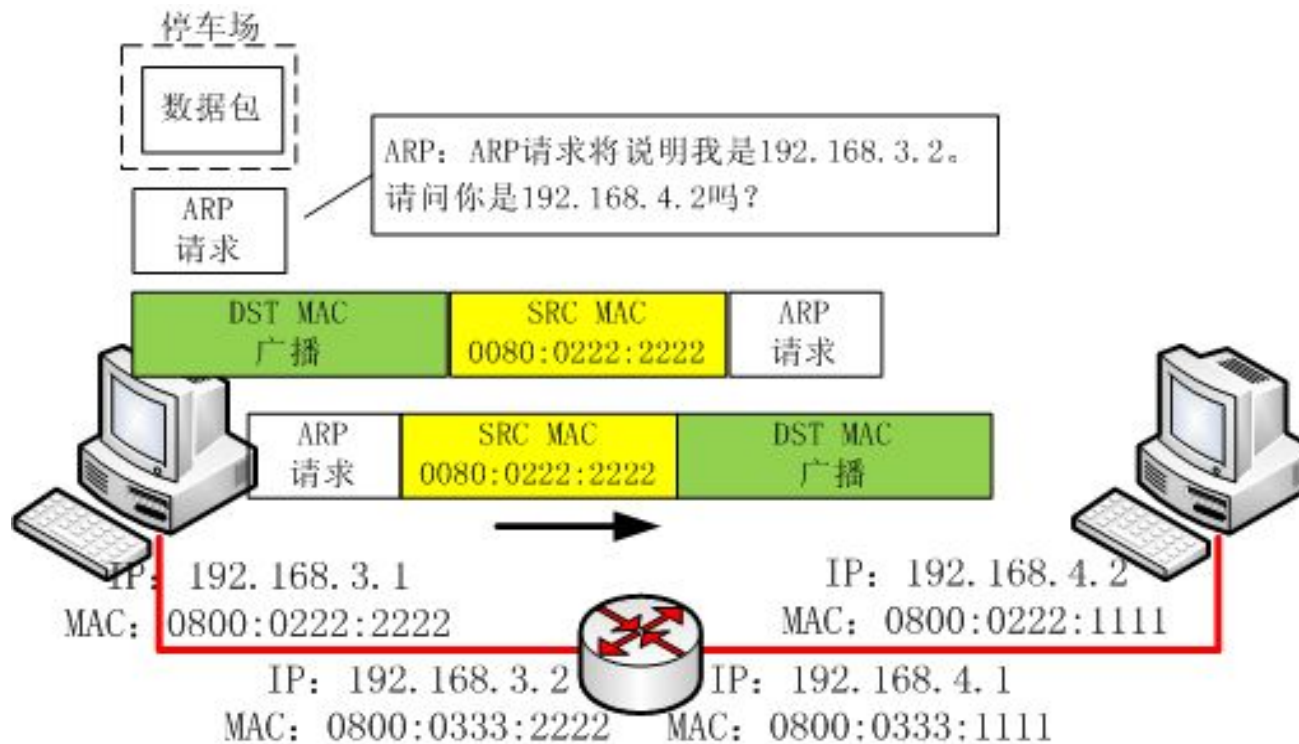



## 第6步：

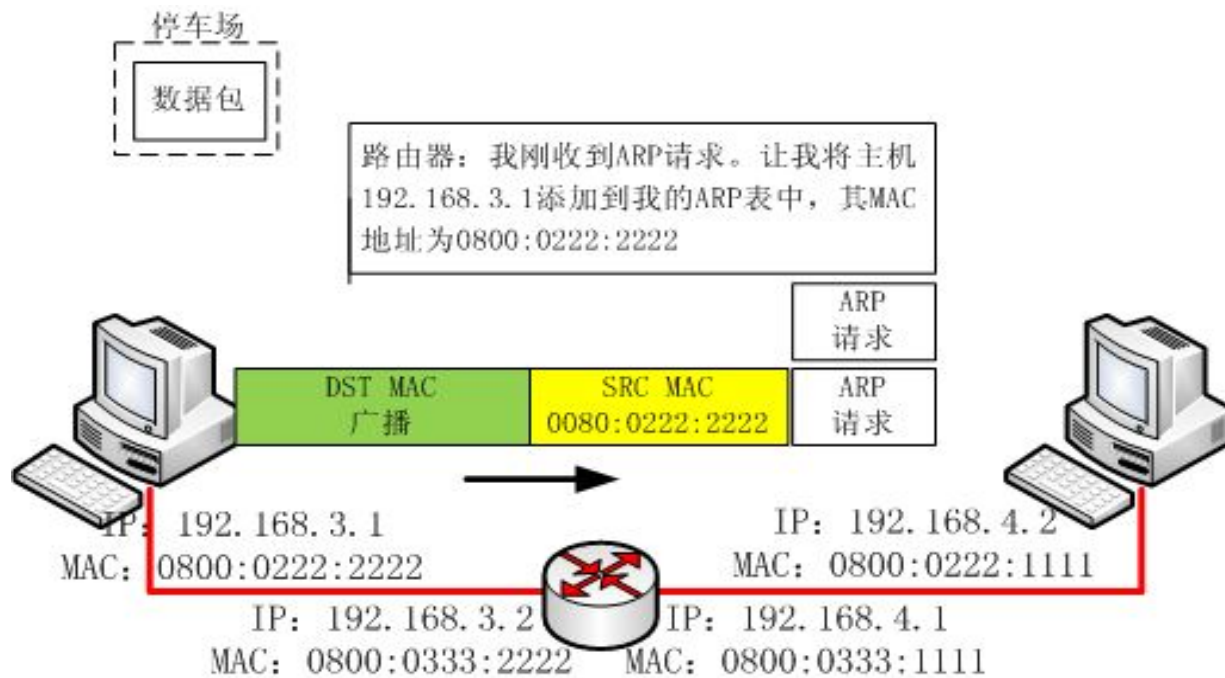



# 第7步：

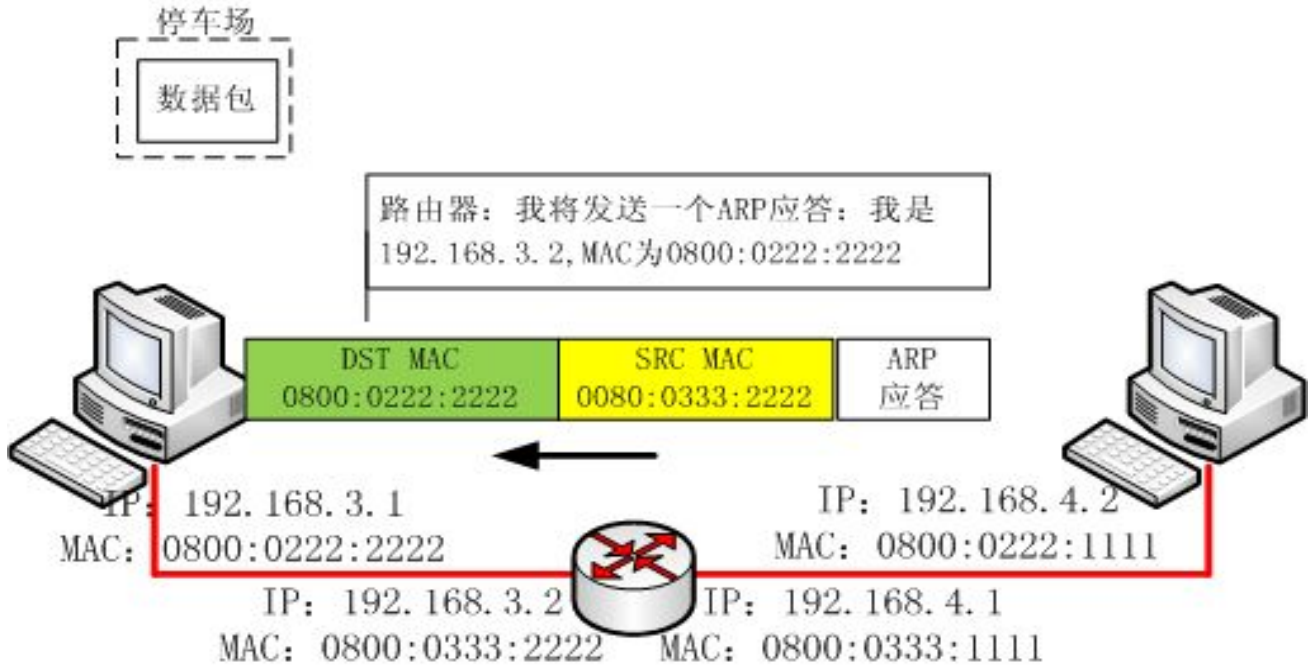





## 第8步：

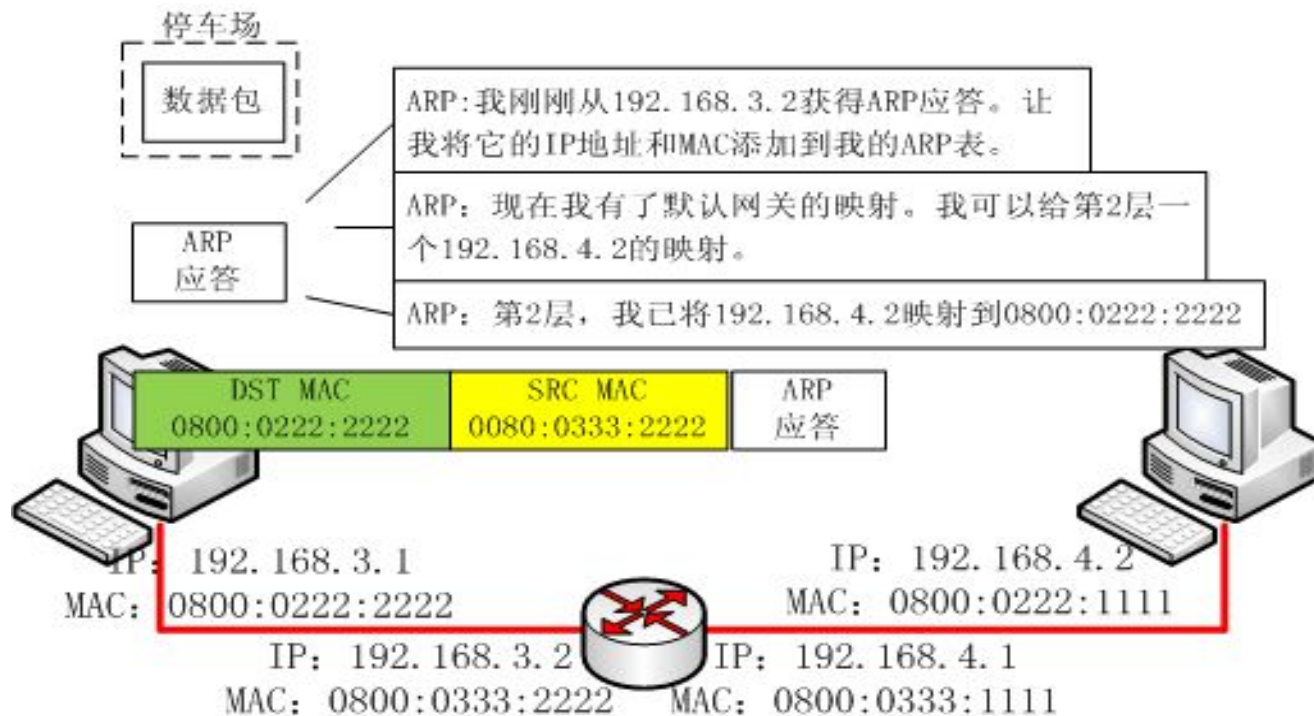



# 第9步：

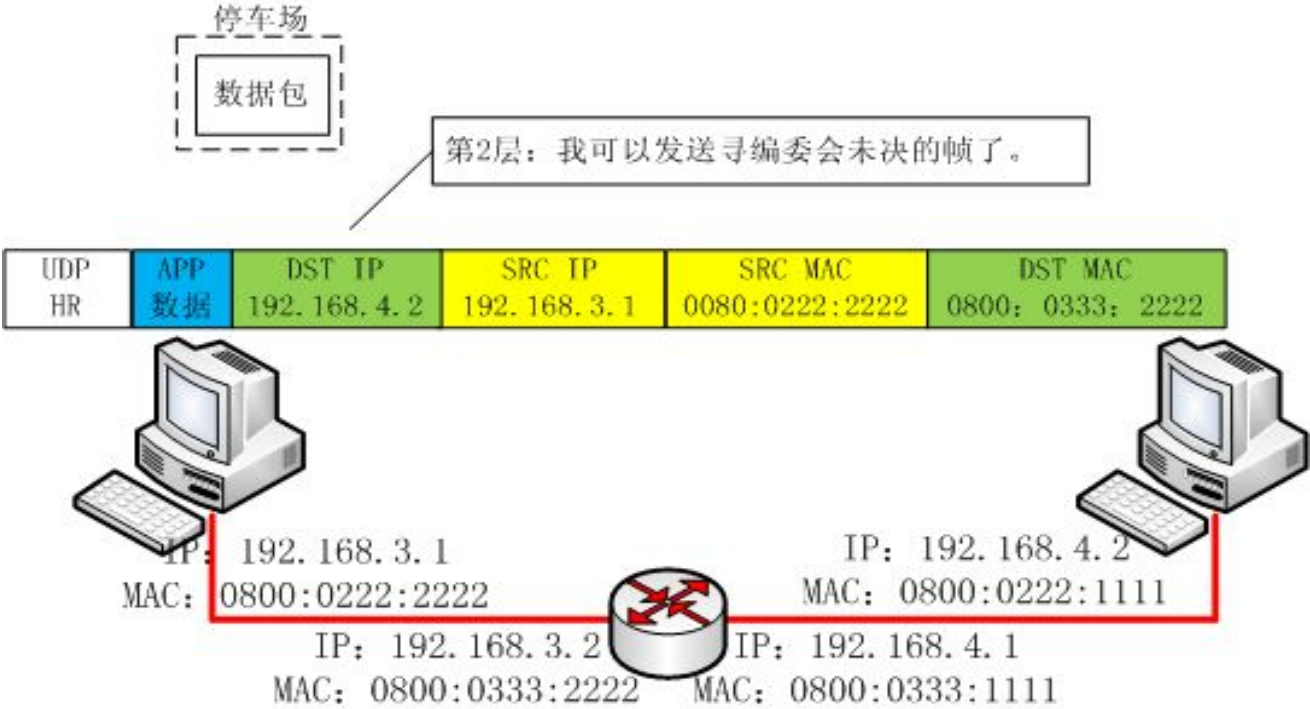



## 第10步：

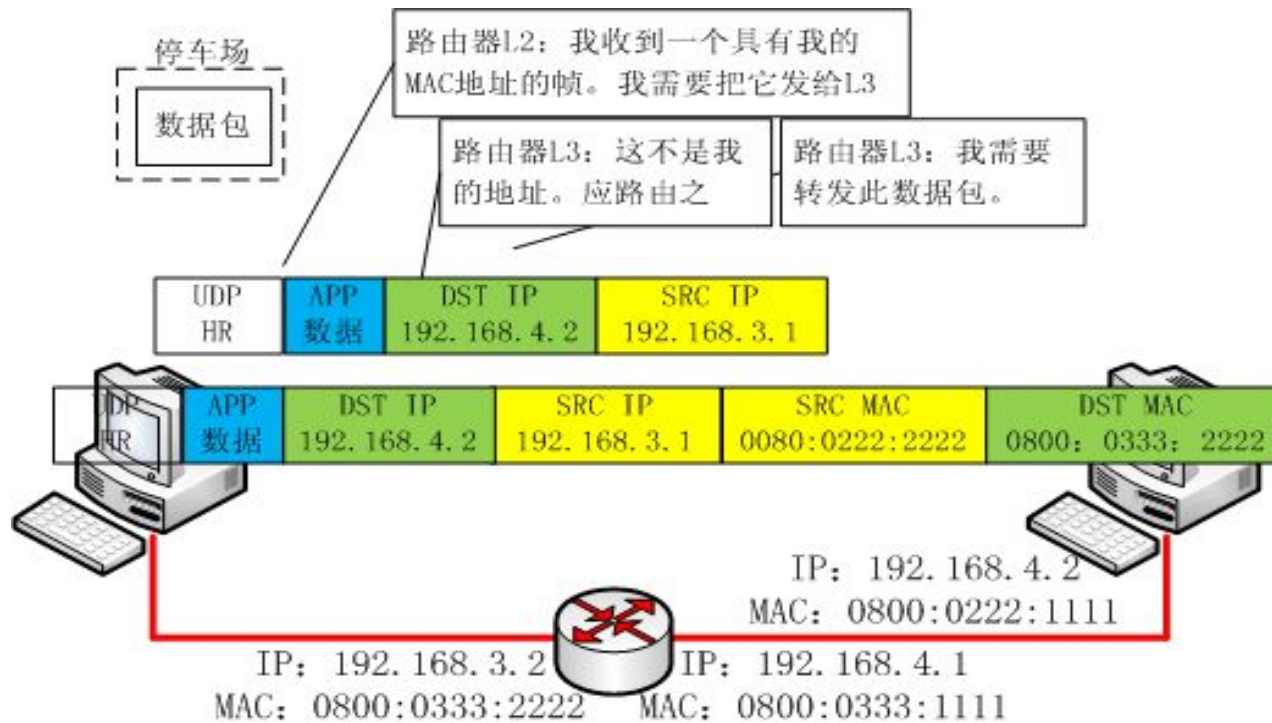



## 第11步：

目的地	下一跳	接口
192.168.3.0/24	相连	fa0/0
192.168.4.0/24	相连	fa0/0

路由器L3：我在网段192.168.4.0/24上有一个接口，我可以把这个数据包直接发送到该主机

路由器L3：L2，请发送这个数据包

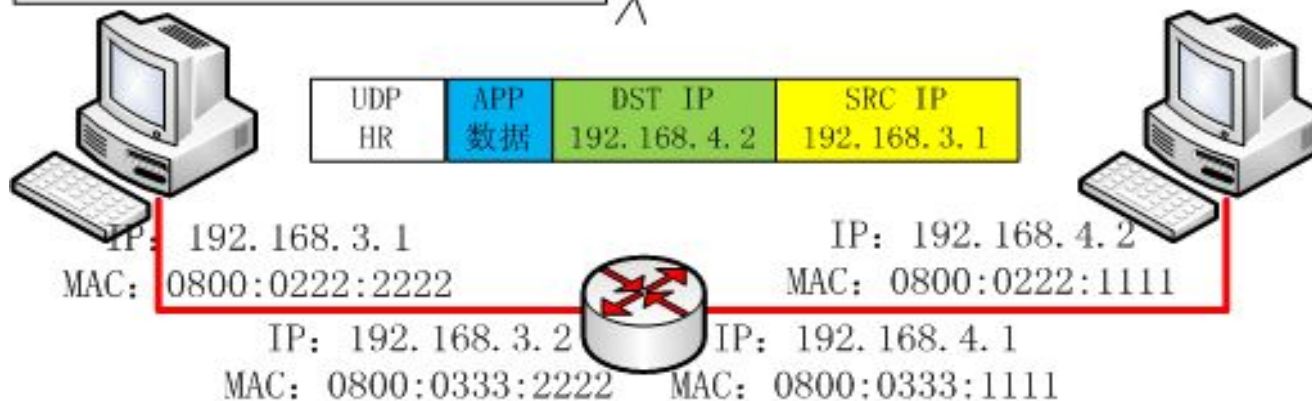



# 第12步：

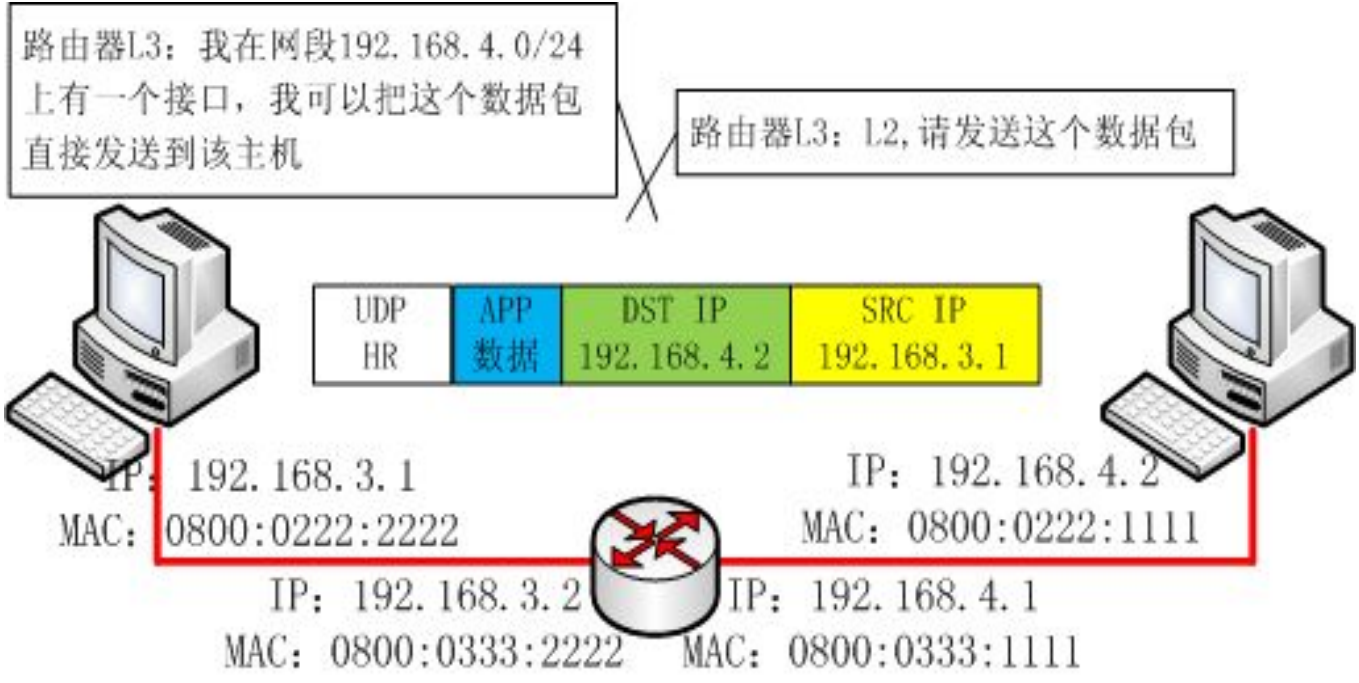



# 第13步：

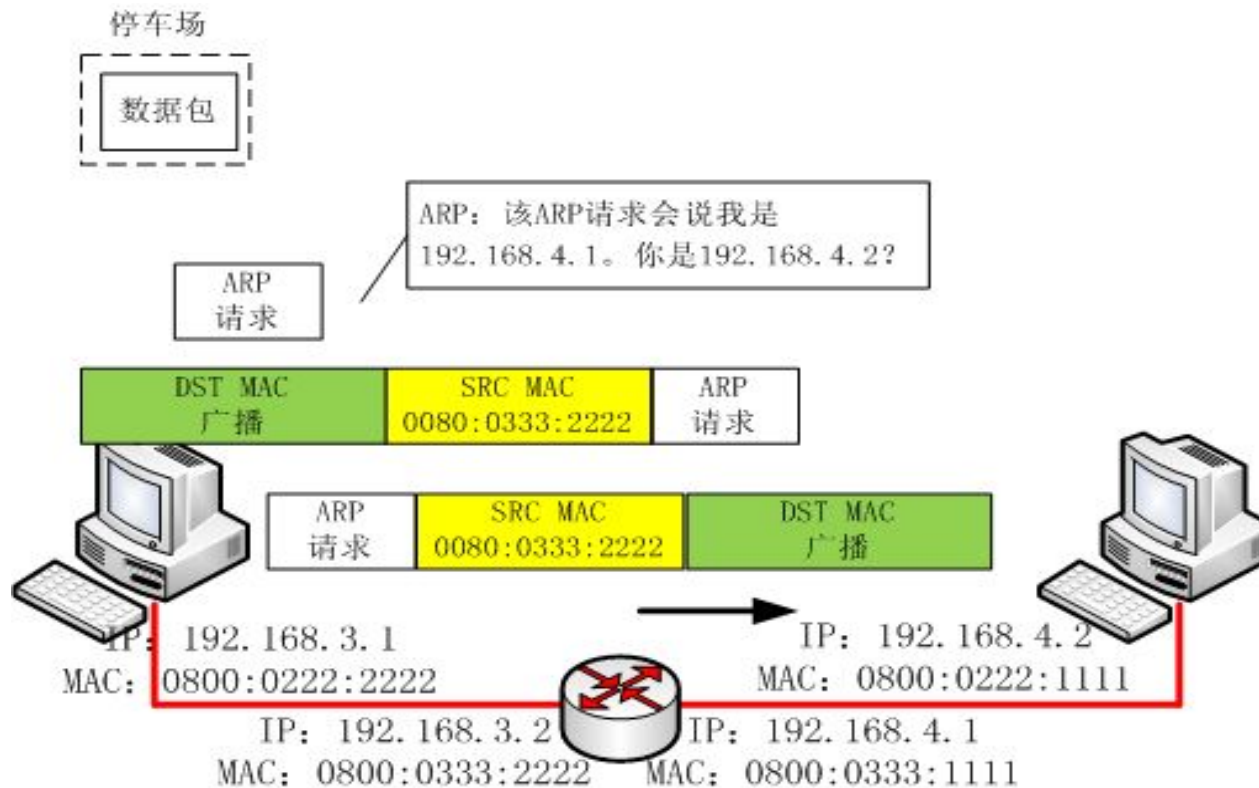



# 第14步：

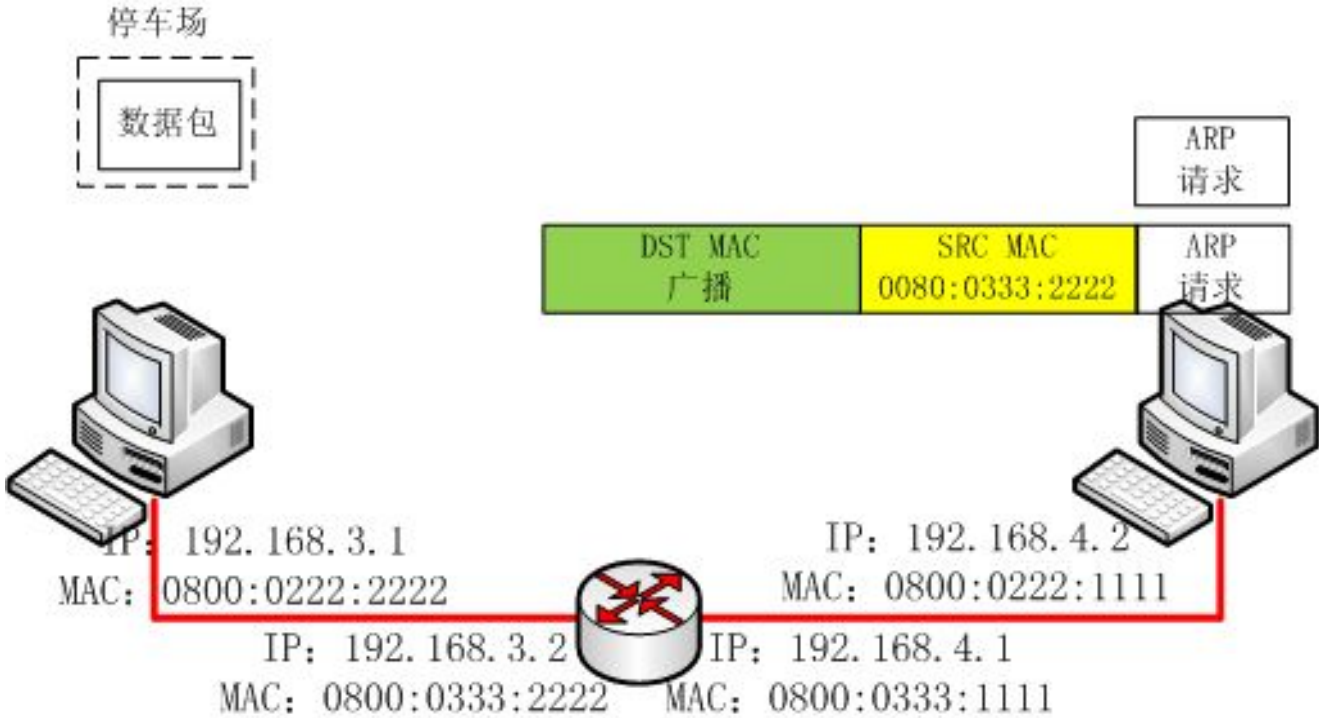





## 第15步：

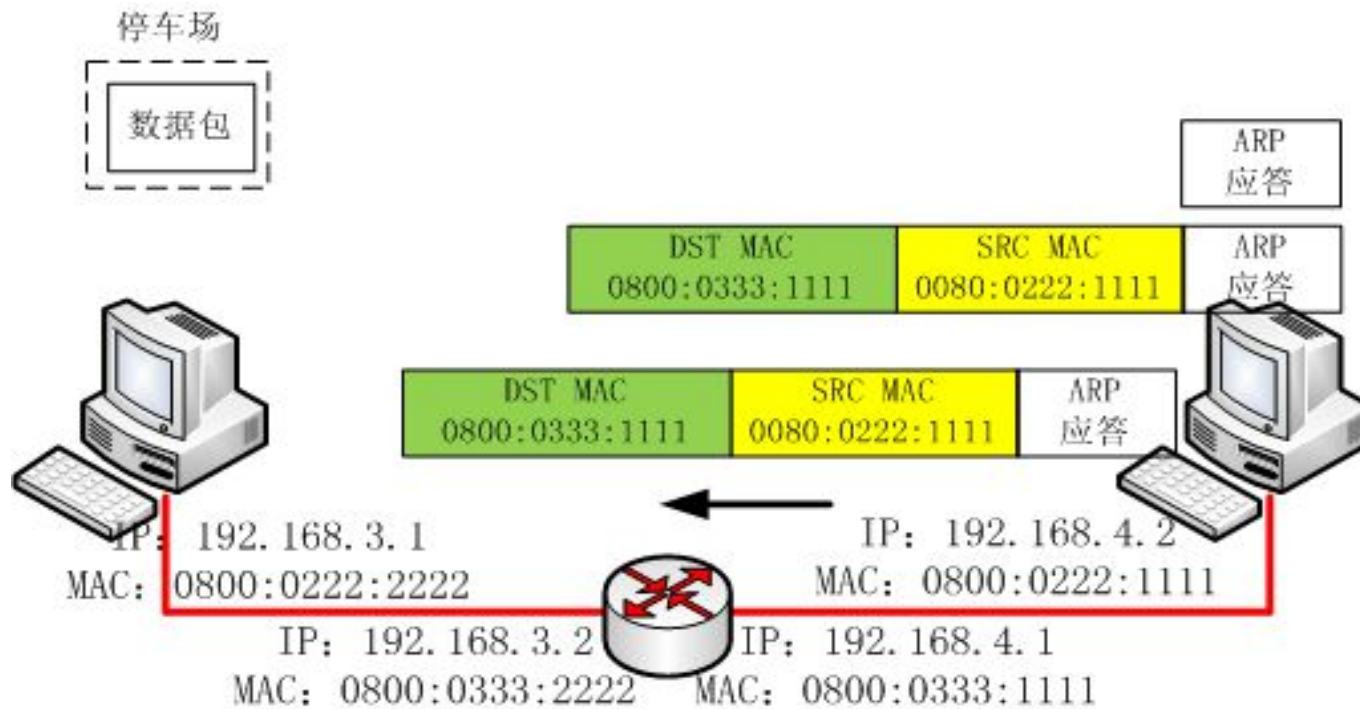





## 第16步：

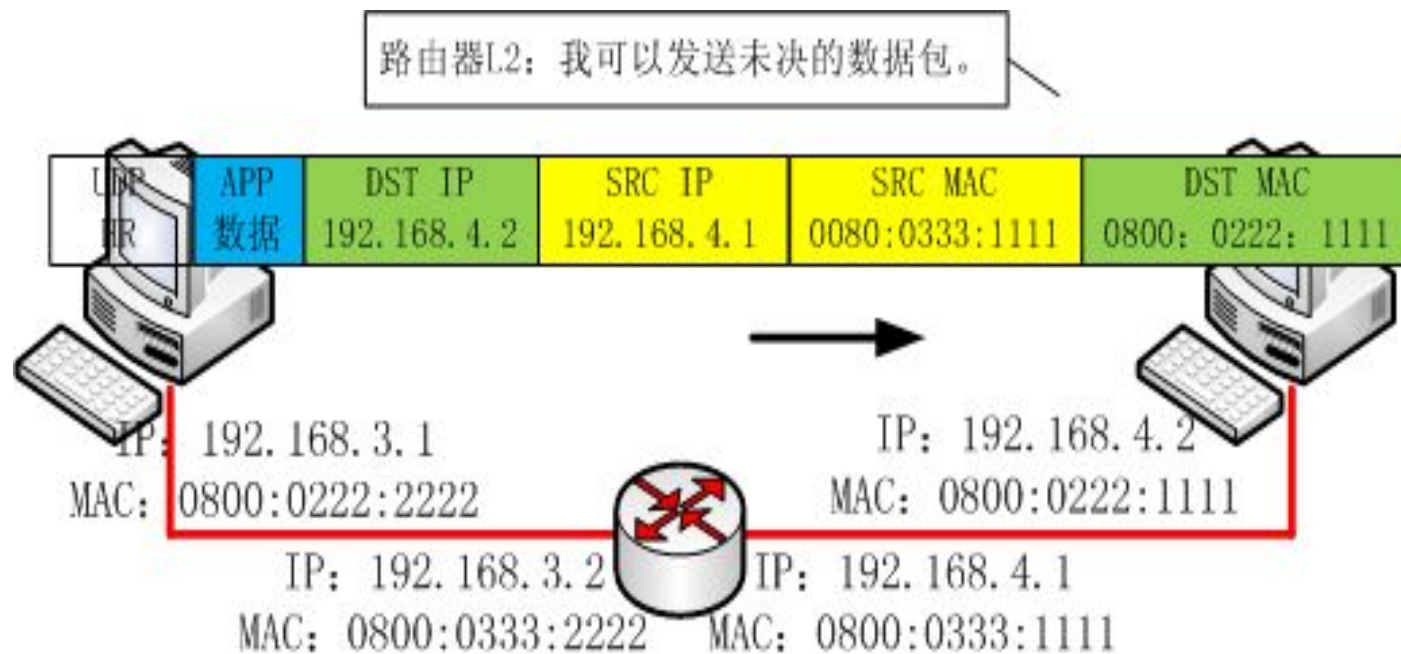



# 感谢聆听！

《两个主机通过路由网络传输IP数据包》